

## Brown Headed Nuthatch Nesting Box Design

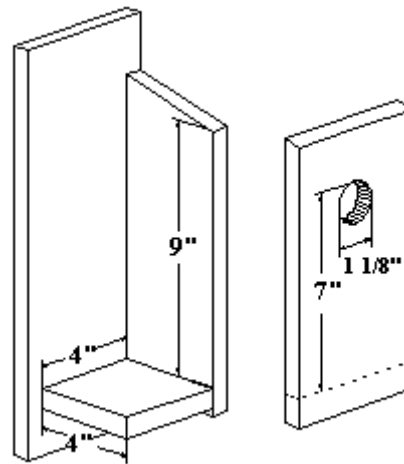

Print Plans & Dimensions (below)



Species Dimensions

**Chestnut-backed Chickadees, Siberian Chickadees,  
Pigmy Nuthatches & Brown-headed Nuthatches**

- Durable Rough-Cut Red Cedar
- Screw Assembly, Pre-Drilled Countersunk Pilot Holes
- Hinged Roof Secured with Shutter Hooks for Easy Access
- Corrosion Resistant Hardware

This nest box is constructed with Red Cedar. Wood stock is rough-cut on both sides so birds can grip interior and exterior surfaces.

It has a 4" by 4" floor (inside dimensions), 9" floor to ceiling (inside front), 1 1/8" diameter entrance hole located 7" above the floor (to top of hole) and ventilation openings in the floor and under the roof.

Hinged roof provides easy access for monitoring and cleaning. Shutter hooks secure roof in closed position. Pilot holes in both primary and secondary work pieces makes for easy assembly with screwdriver in minutes.

Mount on a tree, post, fence or wall between four and twelve feet high with partial sun and shade (see specific bird species pages for habitat and mounting instructions.)

Remove the nest in late summer or fall after the brood rearing seasons are over.

See assembly instructions and complete plans below.

## Assembly:

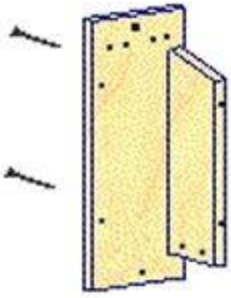

1) Fasten Right Side to Back Panel with screws.

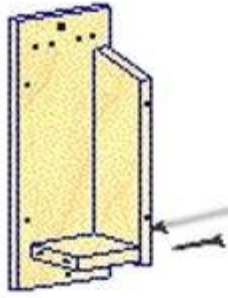

2) Fasten Floor to Right Side and back.

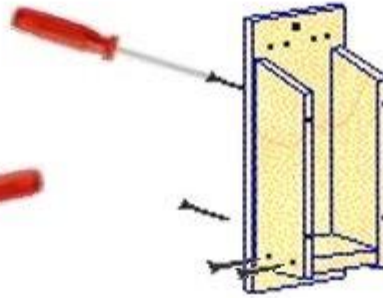

3) Fasten Left Side to Back Panel and Floor.

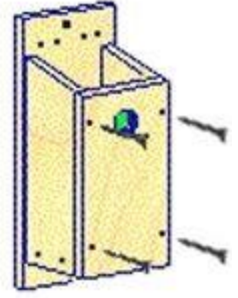

4) Fasten Front Panel.

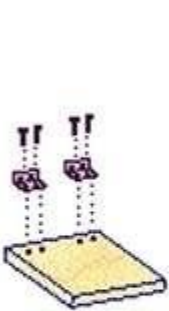

5) Fasten Hinges to Roof with Small Screws.

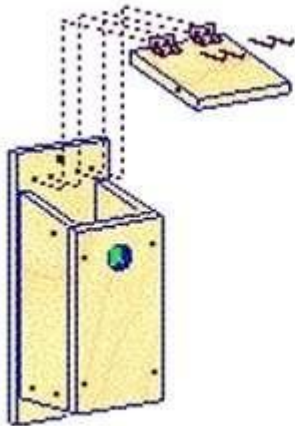

6) Fasten Roof and Hinges to Back Panel.

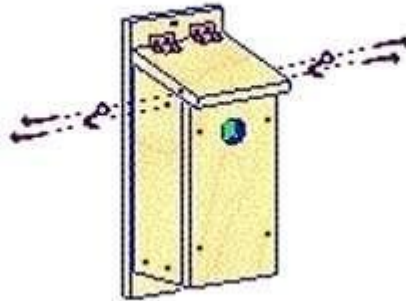

7) Fasten Shutter Hooks to Roof and Sides with Round-head Screws.

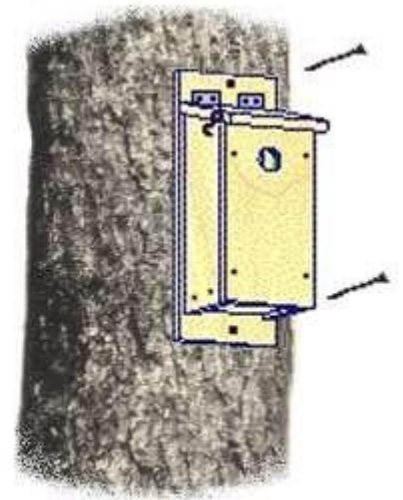

8) Mount Nestbox with Large Screws at appropriate Height (see specific species mounting height and habitat.)

[50birds.com](http://50birds.com)

