



## Great-crested Flycatcher

- Durable Rough-Cut Red Cedar
- Screw Assembly, Pre-Drilled Countersunk Pilot Holes
- Hinged Roof Secured with Shutter Hooks for Easy Access
- Corrosion Resistant Hardware

The [Great-crested Flycatcher](#) nest box is constructed with Red Cedar. Wood stock is rough-cut on both sides so birds can grip interior and exterior surfaces.

It has a 6" by 6" floor, 9" inside ceiling, 1 3/4" diameter entrance hole located 7" above the floor and ventilation openings in the floor and under the roof.

The hinged roof provides easy access for monitoring and cleaning. Shutter hooks secure roof in closed position. Pilot holes in both primary and secondary work pieces makes for easy assembly in minutes.

Mount on tree or post in a secluded area in the woods between six and ten feet high with partial sun and shade. Remove the nest after the brood rearing seasons are over.

Chickadees, Nuthatches, Titmice, Wrens, Tree and Violet Green Swallows may use this nest box.

House Sparrows are attracted to bird houses with entrance holes of the size in this model.

Assembly instructions and plans see reverse.

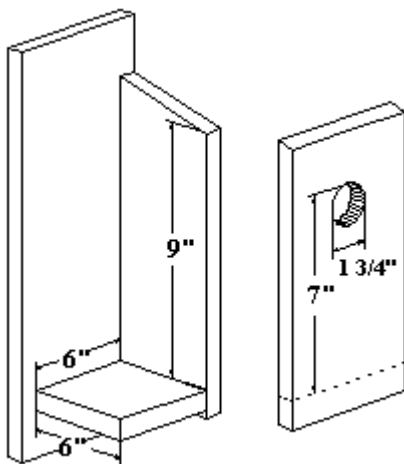

Species Dimensions



## Assembly:

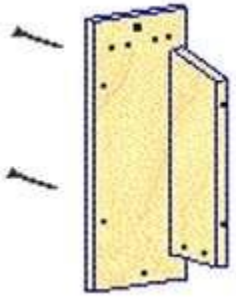

1) Fasten Right Side to Back Panel with screws.

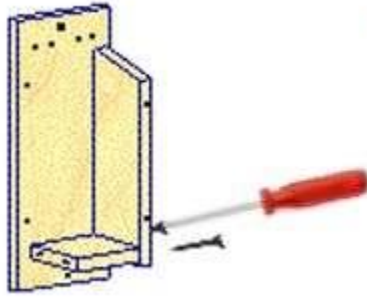

2) Fasten Floor to Right Side and back.

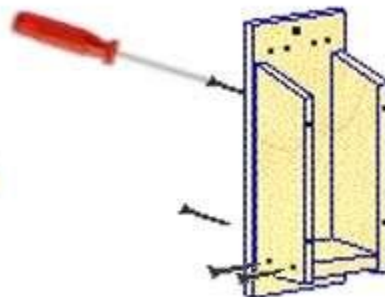

3) Fasten Left Side to Back Panel and Floor.

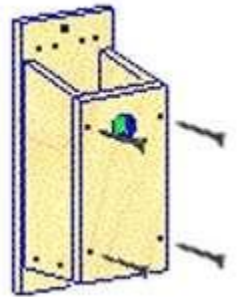

4) Fasten Front Panel.

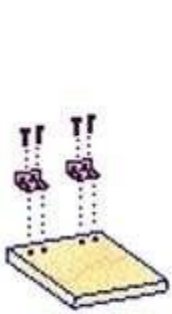

5) Fasten Hinges to Roof with Small Screws.

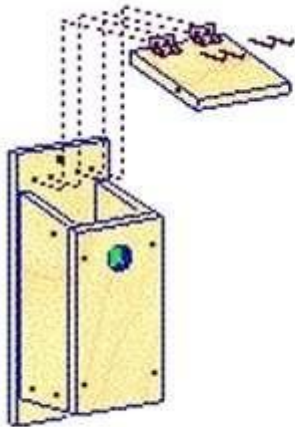

6) Fasten Roof and Hinges to Back Panel.

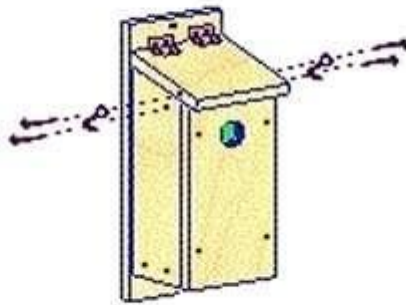

7) Fasten Shutter Hooks to Roof and Sides with Round-head Screws.

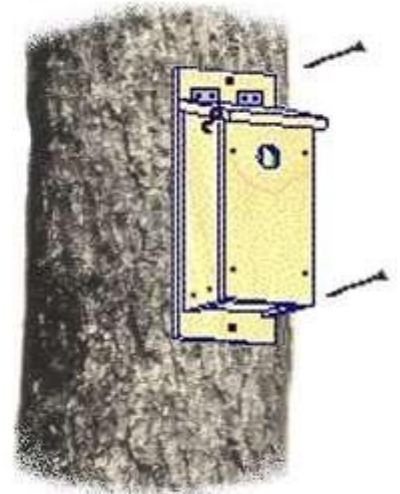

8) Mount Nestbox with Large Screws at appropriate Height (see specific species mounting height and habitat.)

50birds.com

